

# 3D Viewer - User Guide

Version 1.0.0



## TABLE OF CONTENTS

<b>1. EXTENSION OVERVIEW.....</b>	<b>1</b>
<b>2. HOW TO USE THE EXTENSION.....</b>	<b>1</b>
<b>3. CONTACT US.....</b>	<b>5</b>

## 1. EXTENSION OVERVIEW

The 3D Viewer extension allows you to easily embed 3D models into your Magento website. Either you are selling physical products or 3D model related services, the 3D Viewer will generate much more user engagement than static pictures or technical drawings. The process is extremely quick and easy, and does not require any programming skill.

## 2. HOW TO USE THE EXTENSION

Once the extension is correctly installed in your Magento Commerce solution, you can immediately start embedding 3D Models with ease.

Click on the 3D Model Viewer icon available in your editor, from any content or product page.

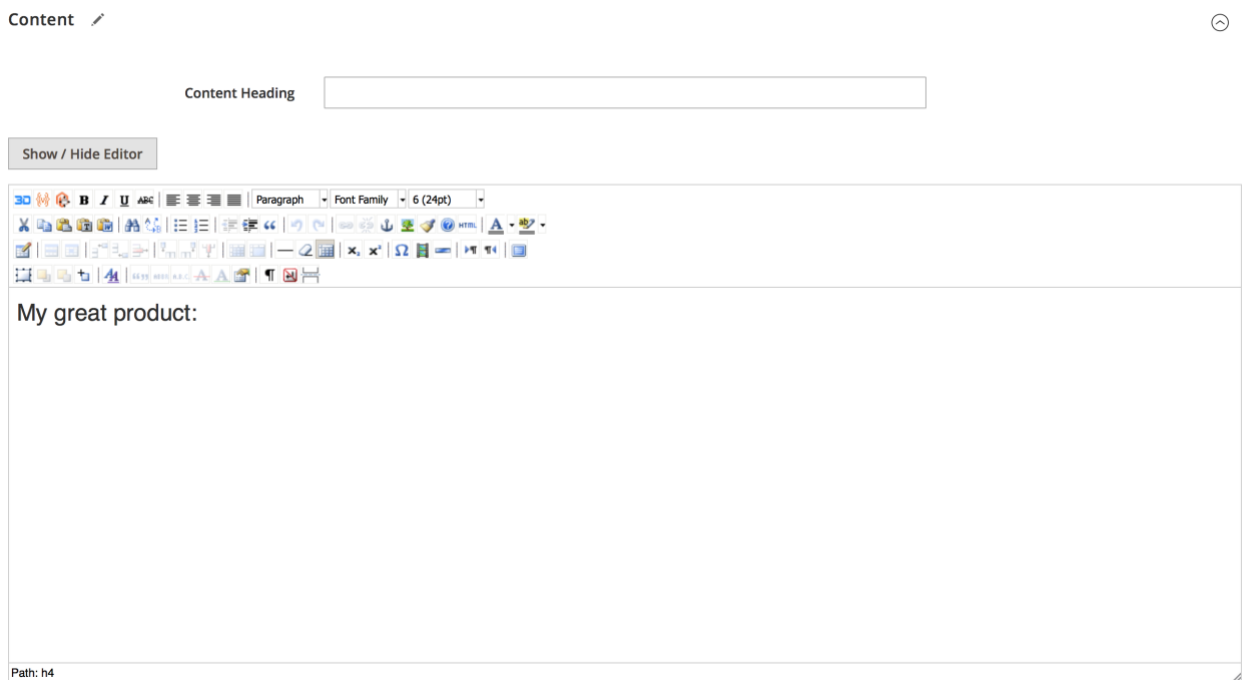

A 3D Model Viewer window will pop up, asking for the 3D Model URL and the 3D Viewer Width and Height.

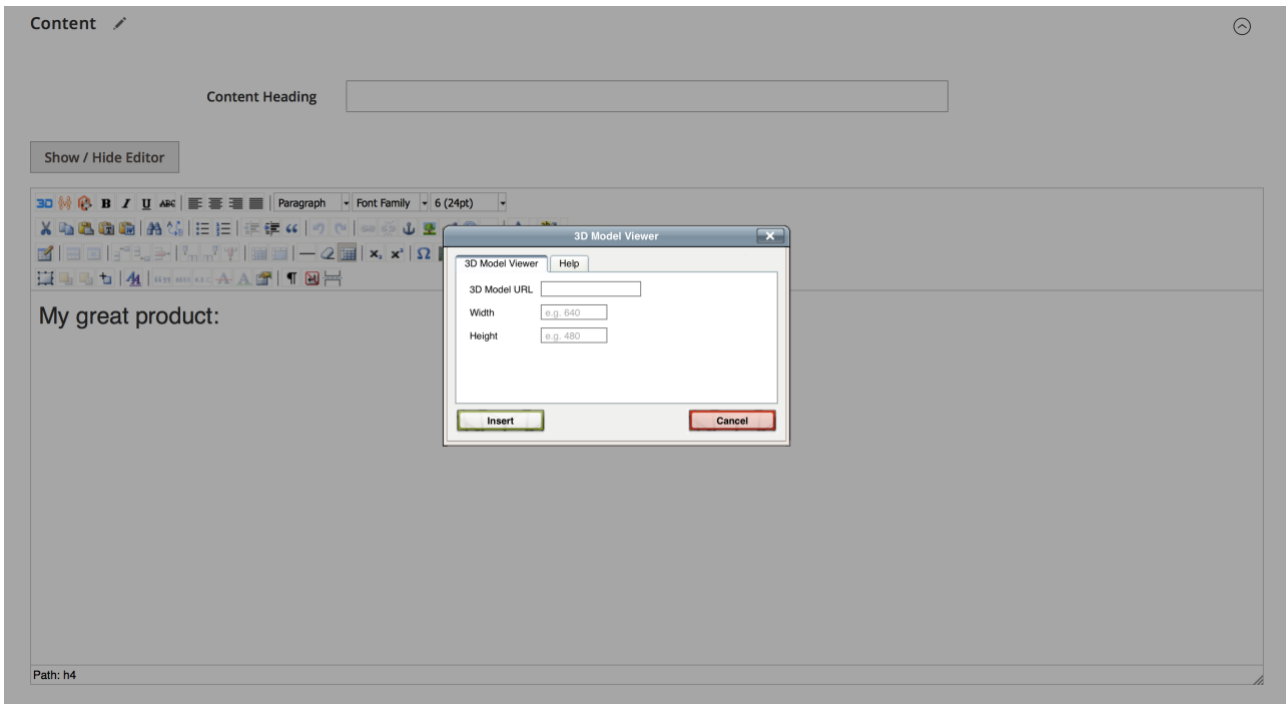

The 3D Model URL can be easily copied from your 3DVieweronline account, a shortcut is provided in the Help section of the 3D Model Viewer window.

Once you logged in 3dvieweronline.com, you can copy the URL (or Link) of the model you want to embed and paste it in the 3D Model URL field.

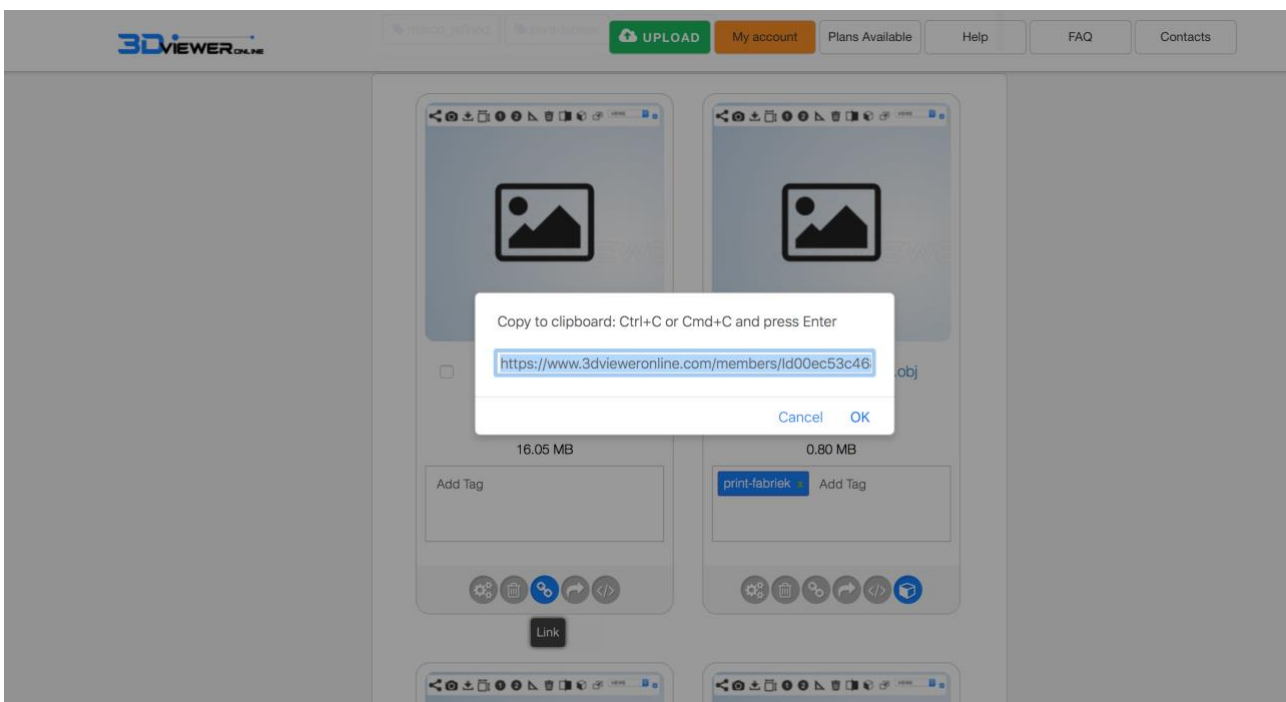

You can also specify the 3D Viewer dimensions in the Width and Height input fields, however if nothing is declared the default values will be used instead (640 x 480).

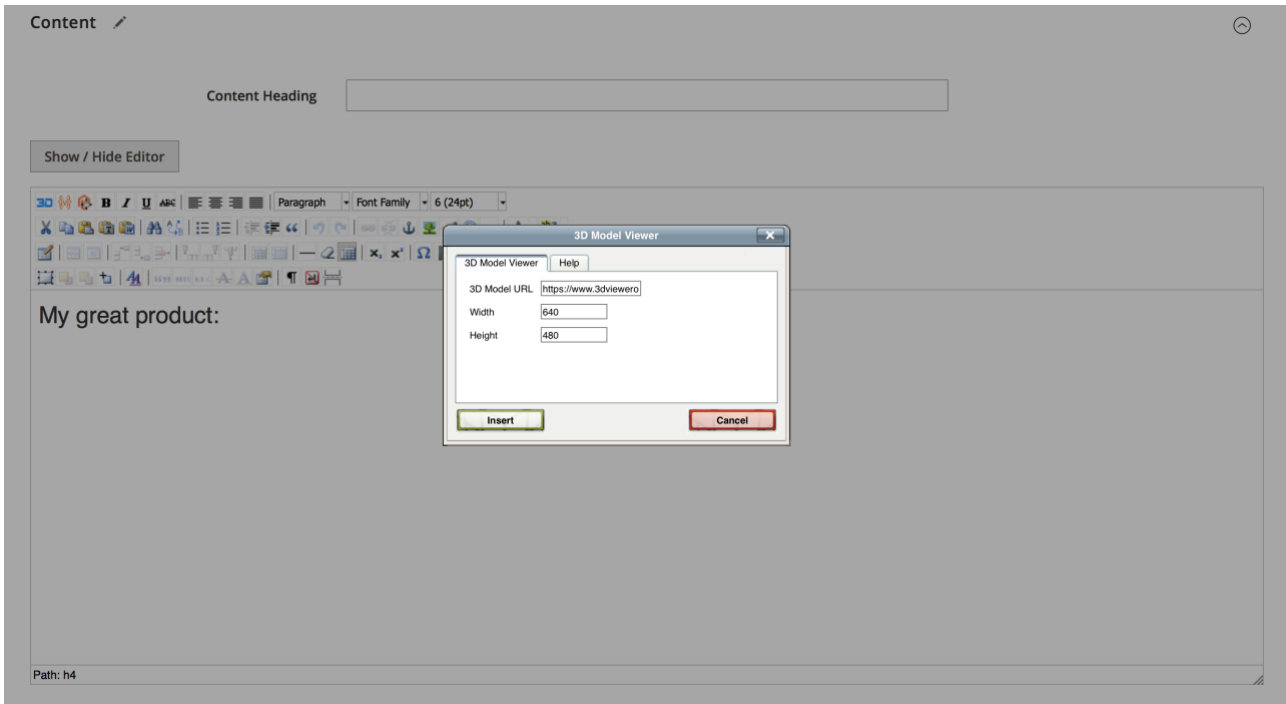

Click on Insert to finalise and the 3D Viewer will be included in your page.

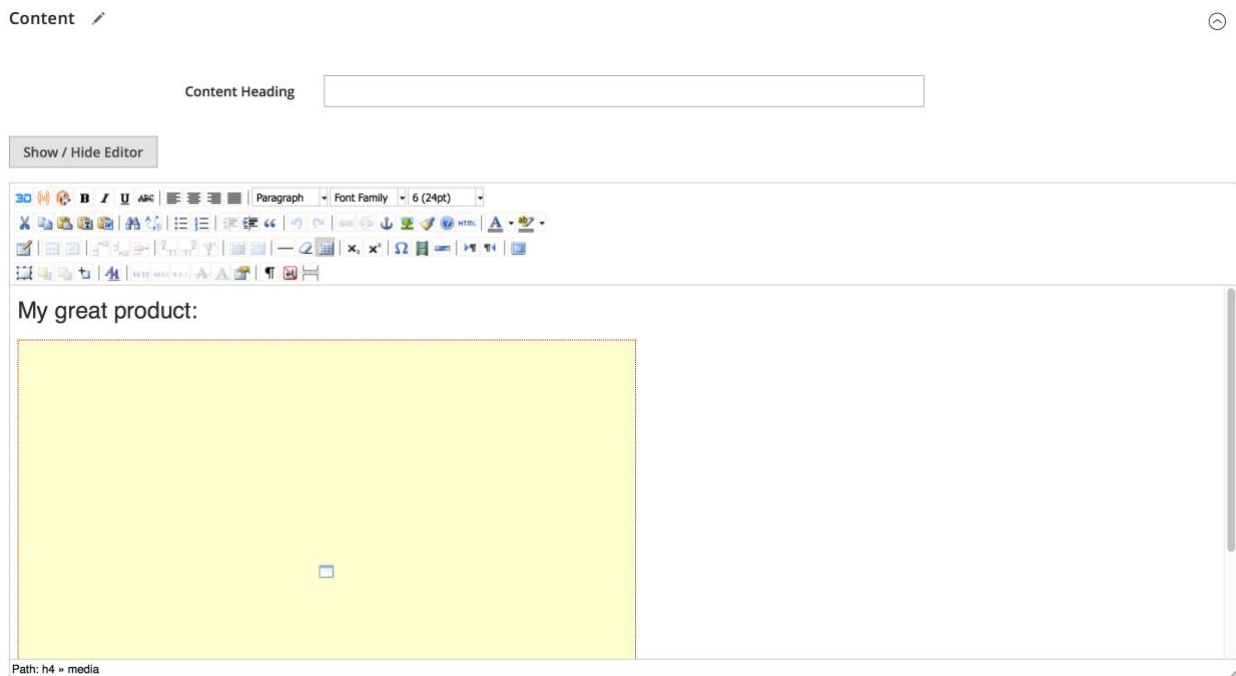

You can embed the 3D Viewer in any section of your website, as long as the editor is available.

3DVieweronline provides different plans, please visit our [plans page](#) for more information.

The premium subscription is specifically suitable for businesses, providing:

- Massive upload capabilities
- More space for your models
- Advanced customisation and embedding options for a seamless integration of the 3D Viewer in your website
- APIs

Here below an example of possible integration (model provided by [Power Belt](#)).

My great product:

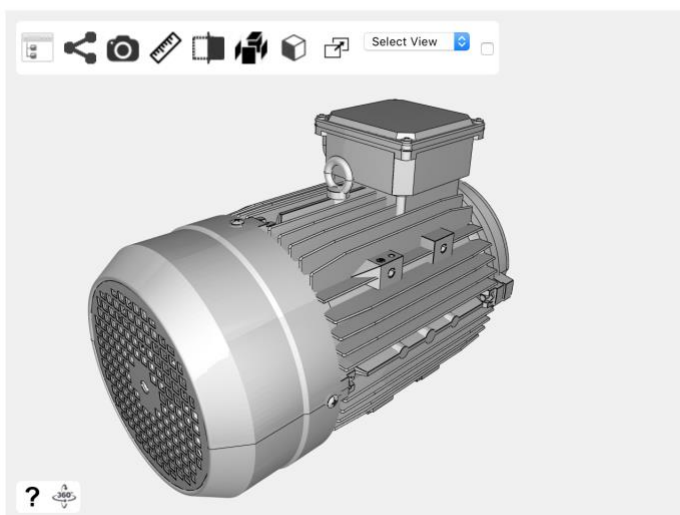

Offering a realistic 3D rendering of your products will increase your credibility and boost your user engagement, resulting in a higher conversion rate. Your customers will be able to navigate and understand much more about your product compared to few static pictures.

They will see each feature in extreme details, they will be able to perform measurements to be sure the product has the correct dimensions and they will be finally able to create sections and exploded views.

Among the many features provided by the 3D Viewer, the exploded view, the sections and the part view are the most used.

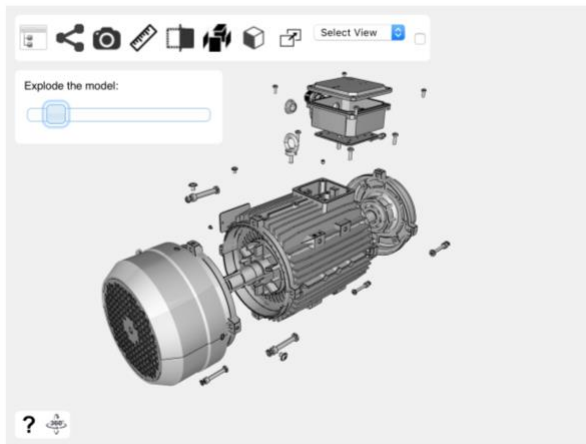

Exploded view

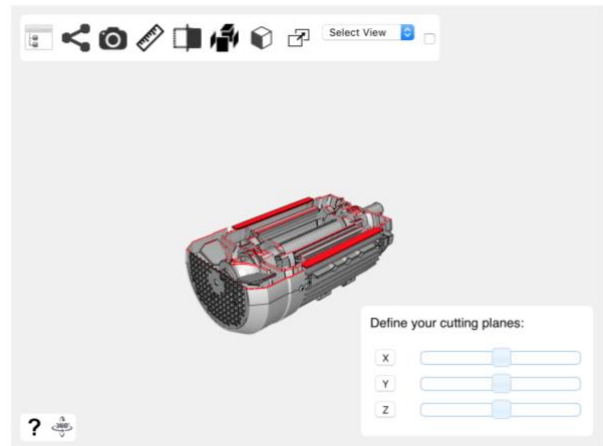

Sections

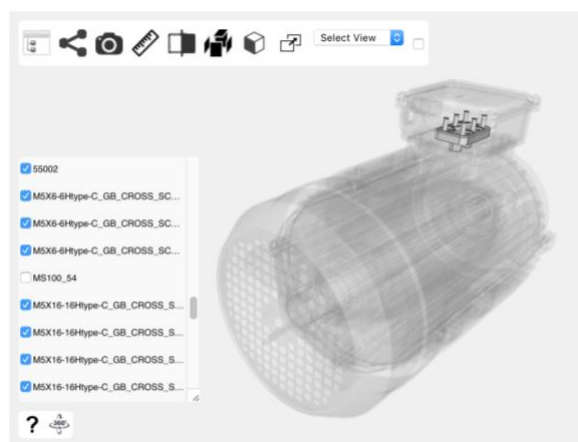

Part view

Your customers will be able to better understand your product, making quicker and easier purchase decisions.

### 3. CONTACT US

To get in touch with please use the [contact form](#) available on our website.